

# FIAT-ALLIS-DOZERS & SCRAPERS

Cutting Edges



**T O U G H  
C O M P O N E N T S**

**TYPE**

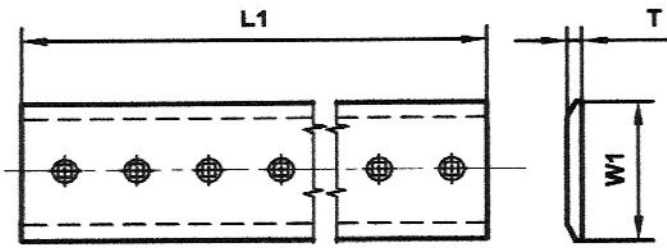

**TYPE 2**

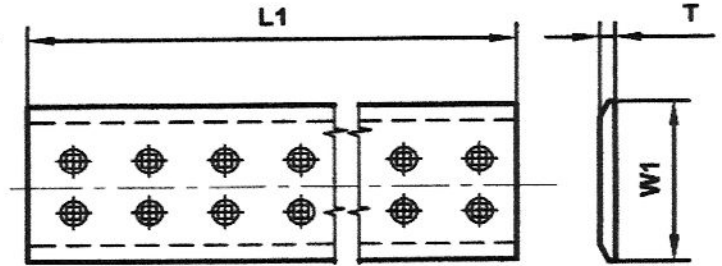

**TYPE**

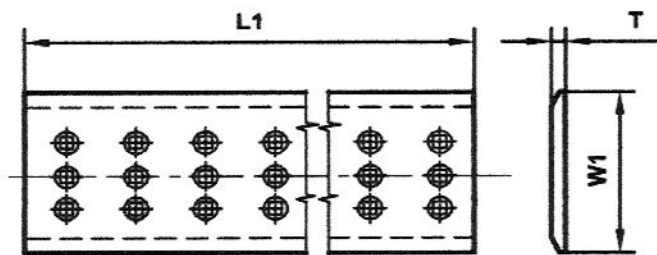

**TYPE 4**

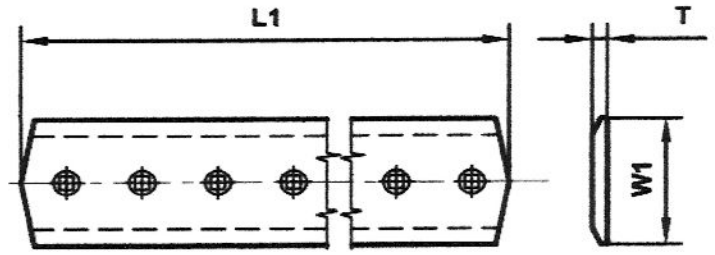

# FIAT-ALLIS-DOZERS & SCRAPERS

End-Bits



**T O U G H  
C O M P O N E N T S**

**TYPE 1**  
(Finish)

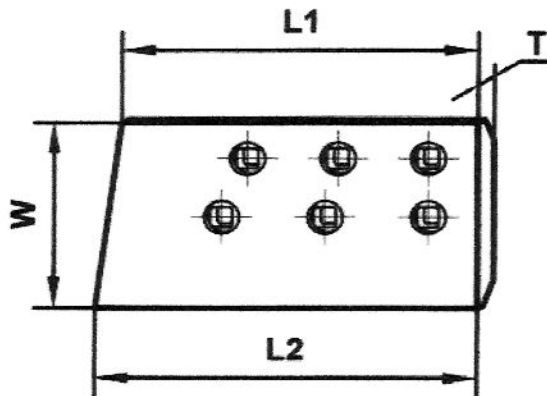

**TYPE 3**  
(General Duty)

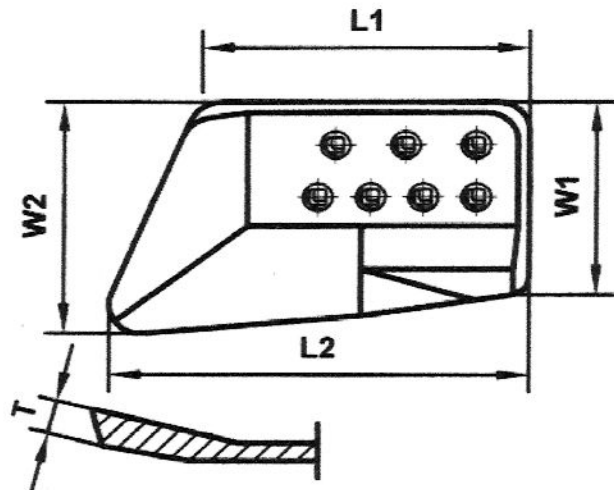

**TYPE 4**  
(Hot Cupped)

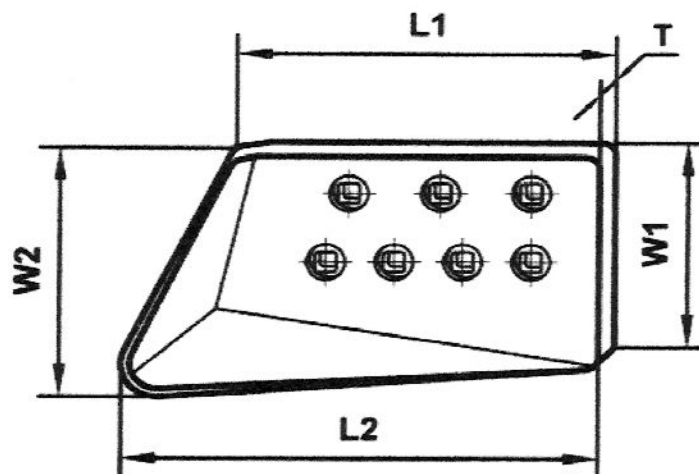

# FIAT-ALLIS-DOZERS&SCRAPERS

Cutting Edges and End Bits



**T O U G H  
COMPONENTS**

Tractor Type	Blade Model	O.E.M. Part Nr.	MTM Number	Ref.	Description	No Pcs	Millimeters					Qt. ty.	Nr. H.	Bolt Ø	W. Kg.
							W1	W2	L1	L2	T				
FD50	Semi U	70696788	003-Q00-63	1	C.E. BULL STD CTR	3	300		1367		45	MT2	9	1 1/4"	138,5
		73113880	003-957-R42	4	E.B. BULL STD RH HC	1	330	370	603	695	50	MT3	7	1 1/4"	88,5
		73113879	003-957-L42	4	E.B. BULL STD LH HC	1	330	370	603	695	50	MT3	7	1 1/4"	88,5
	Full "U" STD	73109991	003-Q00-37	1	C.E. BULL STD CTR	2	300		1673		45	MT2	11	1 1/4"	169,4
		73109992	003-Q00-96	1	C.E. BULL STD AMBI	2	300		905		45	MT2	6	1 1/4"	91,6
		73113596	003-959-R66	4	E.B. BULL STD RH HC	1	330	379	670	774	50	MT3	8	1 1/4"	97,0
		73113595	003-959-L66	4	E.B. BULL STD LH HC	1	330	379	670	774	50	MT3	8	1 1/4"	97,0
	Full "U" HD	73113280	003-Q00-40	1	C.E. BULL STD CTR	2	350		1673		50	MT3	11	1 1/4"	219,2
		73113594	003-Q01-20	1	C.E. BULL STD AMBI	2	350		549		50	MT3	4	1 1/4"	67,9
		73113278	003-959-R66	4	E.B. BULL STD RH HC	1	330	379	670	774	50	MT3	8	1 1/4"	97,0
		73113277	003-959-L66	4	E.B. BULL STD LH HC	1	330	379	670	774	50	MT3	8	1 1/4"	97,0
	Straight	70663854	003-Q00-74	1	C.E. BULL STD CTR GD	2	300		1211		35	MT2	8	1 1/4"	95,4
		70684288	003-653-R51	1	E.B. BULL STD RH FD	1	305	305	523	555	30	MT2	6	1 1/4"	36,0
70684287		003-653-L51	1	E.B. BULL STD LH FD	1	305	305	523	555	30	MT2	6	1 1/4"	36,0	
41B	HU Full "U" 18'	70698861	003-Q00-38	1	C.E. BULL STD CTR GD	2	300		1673		35	MT2	11	1 1/4"	131,7
		AC1-DC603		1	C.E. BULL STD AMBI	2							4	1 1/4"	
		73109991	003-Q00-37	1	C.E. BULL STD CTR HD	2	300		1673		45	MT2	11	1 1/4"	169,4
		AC1-DC604			C.E. BULL STD	2							4	1 1/4"	
		73113280	003-Q00-40	1	C.E. BULL STD CTR EXT-HD	2	350		1673		50	MT3	11	1 1/4"	219,2
		73113594	003-Q01-20	1	C.E. BULL STD AMBI	2	350		549		50	MT3	4	1 1/4"	67,9
		70697086	003-955-R66	4	E.B. BULL STD RH HC	1	330	379	670	774	45	MT2	8	1 1/4"	87,0
		70697085	003-955-L66	4	E.B. BULL STD LH HC	1	330	379	670	774	45	MT2	8	1 1/4"	87,0
		73113278	003-959-R66	4	E.B. BULL STD RH HC	1	330	379	670	774	50	MT3	8	1 1/4"	97,0
73113277	003-959-L66	4	E.B. BULL STD LH HC	1	330	379	670	774	50	MT3	8	1 1/4"	97,0		
HD 41 41B	HU Full "U" Up to 47M 1499	70663503	003-Q00-62	1	C.E. BULL STD CTR GD	2	300		1367		35	MT2	9	1 1/4"	107,7
		70674048	003-Q00-70	1	C.E. BULL STD AMBI GD	2	300		1240		35	MT2	8	1 1/4"	97,7
		70696788	003-Q00-63	1	C.E. BULL STD CTR HD	2	300		1367		45	MT2	9	1 1/4"	138,5
		70696790	003-Q00-69	1	C.E. BULL STD AMBI HD	2	300		1240		45	MT2	8	1 1/4"	125,6
		73113279	003-Q00-64	1	C.E. BULL STD CTR EXT-HD	2	350		1367		50	MT3	9	1 1/4"	179,6
		73113268	003-Q00-71	1	C.E. BULL STD AMBI EXT-HD	2	350		1240		50	MT3	8	1 1/4"	162,2
		70697086	003-955-R66	4	E.B. BULL STD RH HC	1	330	379	670	774	45	MT2	8	1 1/4"	87,0
		70697085	003-955-L66	4	E.B. BULL STD LH HC	1	330	379	670	774	45	MT2	8	1 1/4"	87,0
		73113278	003-959-R66	4	E.B. BULL STD RH HC	1	330	379	670	774	50	MT3	8	1 1/4"	97,0
73113277	003-959-L66	4	E.B. BULL STD LH HC	1	330	379	670	774	50	MT3	8	1 1/4"	97,0		
41B	HU Full "U" Up to 47M 1500 Up	70698861	003-Q00-38	1	C.E. BULL STD CTR GD	2	300		1673		35	MT2	11	1 1/4"	131,7
		70698863	003-Q00-97	1	C.E. BULL STD AMBI GD	2	300		905		35	MT2	6	1 1/4"	71,3
		73109991	003-Q00-37	1	C.E. BULL STD CTR HD	2	300		1673		45	MT2	11	1 1/4"	169,4
		73109992	003-Q00-96	1	C.E. BULL STD AMBI HD	2	300		905		45	MT2	6	1 1/4"	91,6
		73113280	003-Q00-40	1	C.E. BULL STD CTR EXT-HD	2	350		1673		50	MT3	11	1 1/4"	219,2
		73113281	003-Q00-98	1	C.E. BULL STD AMBI EXT-HD	2	350		905		50	MT3	6	1 1/4"	118,8
		70697086	003-955-R66	4	E.B. BULL STD RH HC	1	330	379	670	774	45	MT2	8	1 1/4"	87,0
		70697085	003-955-L66	4	E.B. BULL STD LH HC	1	330	379	670	774	45	MT2	8	1 1/4"	87,0
		73113278	003-959-R66	4	E.B. BULL STD RH HC	1	330	379	670	774	50	MT3	8	1 1/4"	97,0
73113277	003-959-L66	4	E.B. BULL STD LH HC	1	330	379	670	774	50	MT3	8	1 1/4"	97,0		
HD41 41B	HSU Semi "U"	70663503	003-Q00-62	1	C.E. BULL STD CTR GD	3	300		1367		35	MT2	9	1 1/4"	107,7
		70696788	003-Q00-63	1	C.E. BULL STD CTR HD	3	300		1367		45	MT2	9	1 1/4"	138,5
		73113279	003-Q00-64	1	C.E. BULL STD CTR EXT-HD	3	350		1367		50	MT3	9	1 1/4"	179,6
		73115302	003-956-R42	4	E.B. BULL STD RH HC	1	330	370	603	695	45	MT2	7	1 1/4"	76,0
		73115301	003-956-L42	4	E.B. BULL STD LH HC	1	330	370	603	695	45	MT2	7	1 1/4"	76,0
		73113276	003-958-R42	4	E.B. BULL STD RH HC	1	330	370	603	695	55	MT3	7	1 1/4"	101,0
73113275	003-958-L42	4	E.B. BULL STD LH HC	1	330	370	603	695	55	MT3	7	1 1/4"	101,0		

Our parts are not original but they are interchangeable with them. The O.E.M. Part Numbers are give for reference purposes only.

# FIAT-ALLIS-DOZERS&SCRAPERS

Cutting Edges and End Bits



**T O U G H  
C O M P O N E N T S**

Tractor Type	Blade Model	O.E.M. Part Nr.	MTM Number	Ref.	Description	No Pcs	Millimeters					QI ty.	Nr. H.	Bolt Ø	W. Kg.	
							W1	W2	L1	L2	T					
HD41 41B 31	HC	70663854	003-Q00-74	1	C.E. BULL STD CTR GD	2	300		1209		35	MT2	8	1 1/4"	95,2	
	Straight	73113273	003-Q00-76	1	C.E. BULL STD CTR HD	2	330		1209		35	MT2	8	1 1/4"	104,7	
		73113274	003-Q00-75	1	C.E. BULL STD CTR EXT-HD	2	330		1209		40	MT2	8	1 1/4"	119,7	
	HC	73113270	003-653-R51	1	E.B. BULL STD RH FD	1	305	305	523	555	30	MT2	6	1 1/4"	36,0	
		73113269	003-653-L51	1	E.B. BULL STD LH FD	1	305	305	523	555	30	MT2	6	1 1/4"	36,0	
		70663855			E.B. BULL STD AMBI	2							6	1 1/4"		
FD40	Semi "U"	73113273	003-Q00-76	1	C.E. BULL STD CTR HD	2	330		1029		35	MT2	8	1 1/4"	89,1	
		73113880	003-957-R42	4	E.B. BULL STD RH HC	1	330	370	603	695	50	MT2	7	1 1/4"	88,5	
		73113879	003-957-L42	4	E.B. BULL STD LH HC	1	330	370	603	695	50	MT2	7	1 1/4"	88,5	
	Full "U"	73113273	003-Q00-76	1	C.E. BULL STD CTR HD	2	330		1029		35	MT2	8	1 1/4"	89,1	
		73113271	003-Q01-04	4	C.E. BULL STD AMBI HD	2	330		812		35	MT2	5	1 1/4"	70,3	
		73113596	003-959-R66	4	E.B. BULL STD RH HC	1	330	379	670	774	50	MT3	8	1 1/4"	97,0	
		73113595	003-959-L66	4	E.B. BULL STD LH HC	1	330	379	670	774	50	MT3	8	1 1/4"	97,0	
	Straight	70663854	003-Q00-74	1	C.E. BULL STD CTR GD	2	300		1209		35	MT2	8	1 1/4"	95,2	
		70684288	003-653-R51	1	E.B. BULL STD RH FD	1	305	305	523	555	30	MT2	6	1 1/4"	36,0	
		70684287	003-653-L51	1	E.B. BULL STD LH FD	1	305	305	523	555	30	MT2	6	1 1/4"	36,0	
	D40	Straight	73039340	003-Q00-07	1	C.E. BULL STD CTR FD	1	254		3067		25	MT2	20	1"	146,1
			70619720	003-Q00-73	1	C.E. BULL STD CTR GD	1	254		1232		35	MT2	8	1"	82,1
70619403			003-Q00-89	1	C.E. BULL STD AMBI GD	2	254		933		35	MT2	6	1"	62,2	
70619398					E.B. BULL STD RH	1							6	1"		
70619397					E.B. BULL STD LH	1							6	1"		
70691694					E.B. BULL STD AMBI	2							6	1"		
Semi "U"		70619720	003-Q00-73	1	C.E. BULL STD CTR GD	1	254		1232		35	MT2	8	1"	82,1	
		70619403	003-Q00-89	1	C.E. BULL STD AMBI GD	2	254		933		35	MT2	6	1"	62,2	
		73113276	003-958-R42	4	E.B. BULL STD RH HC	1	330	370	603	695	55	MT3	7	1 1/4"	101,0	
		73113275	003-958-L42	4	E.B. BULL STD LH HC	1	330	370	603	695	55	MT3	7	1 1/4"	101,0	
31		HU Full "U"	73113273	003-Q00-76	1	C.E. BULL STD CTR GD	2	330		1029		35	MT2	8	1 1/4"	89,1
			73113271	003-Q01-04	4	C.E. BULL STD AMBI GD	2	330		812		35	MT2	5	1 1/4"	70,3
			73113274	003-Q00-75	1	C.E. BULL STD CTR HD	2	330		1209		40	MT2	8	1 1/4"	119,7
			73113272	003-Q01-03	4	C.E. BULL STD AMBI HD	2	330		812		40	MT2	5	1 1/4"	73,1
	70697086		003-955-R66	4	E.B. BULL STD RH HC	1	330	379	670	774	45	MT2	8	1 1/4"	87,0	
	70697085		003-955-L66	4	E.B. BULL STD LH HC	1	330	379	670	774	45	MT2	8	1 1/4"	87,0	
	73113278		003-959-R66	4	E.B. BULL STD RH HC	1	330	379	670	774	50	MT3	8	1 1/4"	97,0	
	73113277		003-959-L66	4	E.B. BULL STD LH HC	1	330	379	670	774	50	MT3	8	1 1/4"	97,0	
	HSU Semi "U"	70663854	003-Q00-74	1	C.E. BULL STD CTR GD	3	300		1209		35	MT2	8	1 1/4"	95,2	
		73113273	003-Q00-76	1	C.E. BULL STD CTR HD	3	330		1029		35	MT2	8	1 1/4"	89,1	
		73113274	003-Q00-75	1	C.E. BULL STD CTR EXT-HD	3	330		1209		40	MT2	8	1 1/4"	119,7	
		73115302	003-956-R42	4	E.B. BULL STD RH HC	1	330	370	603	695	45	MT2	7	1 1/4"	76,0	
		73115301	003-956-L42	4	E.B. BULL STD LH HC	1	330	370	603	695	45	MT2	7	1 1/4"	76,0	
		73113276	003-958-R42	4	E.B. BULL STD RH HC	1	330	370	603	695	55	MT3	7	1 1/4"	101,0	
D30	Semi "U"	70670089	003-Q00-21	1	C.E. BULL STD CTR	1	203		2457		19	MT2	16	7/8"	71,1	
		70635562			E.B. BULL STD RH	1							6	7/8"		
		70635561			E.B. BULL STD LH	1							6	7/8"		
	Straight	70670089	003-Q00-21	1	C.E. BULL STD CTR	1	203		2457		19	MT2	16	7/8"	71,1	
		70691686			E.B. BULL STD RH	1							6	7/8"		
		70691685			E.B. BULL STD LH	1							6	7/8"		
FD30	21CA	70619646	003-Q00-01	1	C.E. BULL STD CTR FD	1	254		3511		25	MT2	23	1"	167,2	
HD21B	21HA	70675496	003-Q00-42	1	C.E. BULL STD CTR GD	1	254		1658		25	MT2	11	1"	79,0	
HD21A	1194 Up	70670247	003-Q00-88	1	C.E. BULL STD AMBI GD	2	254		925		25	MT2	6	1"	44,1	
21C-21B	Angle	70619404	003-Q00-85	1	C.E. BULL STD CTR HD	1	254		1040		35	MT2	7	1"	69,3	

Our parts are not original but they are interchangeable with them. The O.E.M. Part Numbers are give for reference purposes only.

# FIAT-ALLIS-DOZERS&SCRAPERS

Cutting Edges and End Bits



**T O U G H  
C O M P O N E N T S**

Tractor Type	Blade Model	O.E.M. Part Nr.	MTM Number	Ref.	Description	No Pcs	Millimeters					QI ty.	Nr. H.	Bolt Ø	W. Kg.		
							W1	W2	L1	L2	T						
FD30	21CA	70619720	003-Q00-73	1	C.E. BULL STD AMBI HD	2	254		1232		35	MT2	8	1"	82,1		
HD21B	21HA	73113362	003-Q00-84	1	C.E. BULL STD CTR EXT-HD	1	254		1040		40	MT2	7	1"	79,2		
HD21A	1194 Up	73113361	003-Q00-72	1	C.E. BULL STD AMBI EXT-HD	2	254		1232		40	MT2	8	1"	93,9		
21C-21B	Angle	70691722	003-657-L44	1	E.B. BULL STD LH FD	1	275	275	467	545	40	MT2	5	1"	39,0		
		70691721	003-657-R44	1	E.B. BULL STD RH FD	1	275	275	467	545	40	MT2	5	1"	39,0		
		70691744			E.B. BULL STD RH	1							6	1"			
		70691743			E.B. BULL STD LH	1							6	1"			
		73113364			E.B. BULL STD RH	1							6	1"			
		73113363			E.B. BULL STD LH	1							6	1"			
		FD30	21HU	70669676		4	C.E. BULL STD CTR FD	1	254		1975		25	MT2	13	1"	94,1
HD21B	21CU	70669675	003-Q01-09	1	C.E. BULL STD AMBI FD	2	254		755		25	MT2	5	1"	36,0		
HD21A	12000 Up Full "U"	73113370	003-Q00-30	1	C.E. BULL STD CTR GD	1	254		1975		35	MT2	13	1"	131,4		
21C		73113371	003-Q01-13	1	C.E. BULL STD AMBI GD	2	254		755		35	MT2	5	1"	50,1		
21B		73113372	003-Q00-29	1	C.E. BULL STD CTR HD	1	254		1975		40	MT2	13	1"	150,5		
		73113373	003-Q01-12	1	C.E. BULL STD AMBI HD	2	254		755		40	MT2	5	1"	57,5		
		70691722	003-657-L44	1	E.B. BULL STD LH FD	1	275	275	467	545	40	MT2	5	1"	39,0		
		70691721	003-657-R44	1	E.B. BULL STD RH FD	1	275	275	467	545	40	MT2	5	1"	39,0		
		70691744			E.B. BULL STD RH	1							6	1"			
		70691743			E.B. BULL STD LH	1							6	1"			
		73113364			E.B. BULL STD RH	1							6	1"			
		73113363			E.B. BULL STD LH	1							6	1"			
FD30	21HSU	70661165	003-Q00-08	1	C.E. BULL STD CTR FD	1	254		3048		25	MT2	20	1"	145,2		
HD21	Semi "U" 21CSU	70670252	003-Q00-48	1	C.E. BULL STD CTR GD	2	254		1518		25	MT2	10	1"	72,3		
21C		73113360	003-Q00-50	1	C.E. BULL STD CTR HD	2	254		1518		35	MT2	10	1"	101,1		
21B		73113369	003-Q00-49	1	C.E. BULL STD CTR EXT-HD	2	254		1518		40	MT2	10	1"	115,6		
		70661214			E.B. BULL STD RH	1							7	1"			
		70661213			E.B. BULL STD LH	1							7	1"			
		70673082	003-946-R59	4	E.B. BULL STD RH HC	1	265	320	437	534	35	MT2	7	1"	36,5		
		70673081	003-946-L59	4	E.B. BULL STD LH HC	1	265	320	437	534	35	MT2	7	1"	36,5		
		73113366			E.B. BULL STD RH	1							7	1"			
		73113365			E.B. BULL STD LH	1							7	1"			
		73113368			E.B. BULL STD RH	1							7	1"			
		73113367			E.B. BULL STD LH	1							7	1"			
		FD30	21HS	70655107	003-Q00-11	1	C.E. BULL STD CTR FD	1	254		2914		25	MT2	19	1"	138,8
		HD21A	21CS	70670255	003-Q00-82	1	C.E. BULL STD CTR GD	1	254		1048		25	MT2	7	1"	49,9
			12' 7" 12000 Up	70670247	003-Q00-88	1	C.E. BULL STD AMBI GD	2	254		925		25	MT2	6	1"	44,1
70619404	003-Q00-85			1	C.E. BULL STD CTR HD	1	254		1040		35	MT2	7	1"	69,3		
70619403	003-Q00-89			1	C.E. BULL STD AMBI HD	2	254		933		35	MT2	6	1"	62,2		
70691694					E.B. BULL STD AMBI	2							6	1"			
70619398					E.B. BULL STD RH	1							6	1"			
70619397					E.B. BULL STD LH	1							6	1"			
70619776					E.B. BULL STD RH	1							6	1"			
70619775					E.B. BULL STD LH	1							6	1"			
FD30B	Semi "U"		70670252	003-Q00-48	1	C.E. BULL STD CTR GD	2	254		1518		25	MT2	10	1"	72,3	
70673082		003-946-R59	4	E.B. BULL STD RH HC	1	265	320	437	534	35	MT2	7	1"	36,5			
70673081		003-946-L59	4	E.B. BULL STD LH HC	1	265	320	437	534	35	MT2	7	1"	36,5			
Straight		70675496	003-Q00-42	1	C.E. BULL STD CTR GD	1	254		1658		25	MT2	11	1"	79,0		
		70670247	003-Q00-88	1	C.E. BULL STD AMBI GD	2	254		925		25	MT2	6	1"	44,1		
		70691722	003-657-L44	1	E.B. BULL STD LH FD	1	275	275	467	545	40	MT2	5	1"	39,0		
	70691721	003-657-R44	1	E.B. BULL STD RH FD	1	275	275	467	545	40	MT2	5	1"	39,0			

Our parts are not original but they are interchangeable with them. The O.E.M. Part Numbers are give for reference purposes only.

# FIAT-ALLIS-DOZERS&SCRAPERS

Cutting Edges and End Bits



**T O U G H  
C O M P O N E N T S**

Tractor Type	Blade Model	O.E.M. Part Nr.	MTM Number	Ref.	Description	No Pcs	Millimeters					QI ty.	Nr. H.	Bolt Ø	W. Kg.		
							W1	W2	L1	L2	T						
HD21A	21HS	70619404	003-Q00-85	1	C.E. BULL STD CTR	1	254		1040		35	MT2	7	1"	69,3		
	21CS	70619445	003-Q01-14	1	C.E. BULL STD AMBI	2	254		736		35	MT2	5	1"	49,1		
	11' 4" 1194 Up		70691694			E.B. BULL STD AMBI	2							6	1"		
			70619398			E.B. BULL STD RH	1							6	1"		
			70619397			E.B. BULL STD LH	1							6	1"		
			70619776			E.B. BULL STD RH	1							6	1"		
			70619775			E.B. BULL STD LH	1							6	1"		
HD21	21GE	70614460	003-Q00-04	1	C.E. BULL STD CTR	1	203		3476		25	MT2	23	1"	132,3		
		70614492			E.B. BULL STD RH	1							5	1"			
		70614491			E.B. BULL STD LH	1							5	1"			
	21HD	70609281	003-Q00-03	1	C.E. BULL STD CTR FD	1	203		3486		25	MT2	23	7/8"	132,7		
	21GDC	70617306	003-Q00-61	1	C.E. BULL STD CTR GD	1	200		1384		30	MT2	9	7/8"	62,3		
	21GD	70617282	003-Q00-81	1	C.E. BULL STD AMBI GD	2	200		1048		30	MT2	7	7/8"	47,2		
	21CA		70690676	003-633-R43	1	E.B. BULL STD RH FD	1	210	210	483	540	32	MT2	5	7/8"	26,0	
			70690675	003-633-L43	1	E.B. BULL STD LH FD	1	210	210	483	540	32	MT2	5	7/8"	26,0	
			70617080			E.B. BULL STD RH	1							6	7/8"		
			70617079			E.B. BULL STD LH	1							6	7/8"		
			70607849	003-Q00-13	1	C.E. BULL STD CTR FD	1	203		2762		19	MT2	18	7/8"	79,9	
	21CS	70617307	003-Q00-78	1	C.E. BULL STD CTR GD	1	200		1194		30	MT2	8	7/8"	53,7		
	21BDC		70617305	003-Q01-05	1	C.E. BULL STD AMBI GD	2	200		781		30	MT2	5	7/8"	35,1	
		21BD		70691674		E.B. BULL STD AMBI	2							6	7/8"		
				70691686			E.B. BULL STD RH	1						6	7/8"		
			70691685			E.B. BULL STD LH	1						6	7/8"			
	21LM		70607849	003-Q00-13	1	C.E. BULL STD CTR	1	203		2762		19	MT2	18	7/8"	79,9	
			70612995			E.B. BULL STD AMBI	2							6	7/8"		
	HD20	20GD to 301	70619646	003-Q00-01	1	C.E. BULL STD CTR FD	1	254		3511		25	MT2	23	1"	167,2	
			70675496	003-Q00-42	1	C.E. BULL STD CTR GD	1	254		1658		25	MT2	11	1"	79,0	
			70670247	003-Q00-88	1	C.E. BULL STD AMBI GD	2	254		925		25	MT2	6	1"	44,1	
			70691722	003-657-L44	1	E.B. BULL STD LH FD	1	275	275	467	545	40	MT2	5	1"	39,0	
			70691721	003-657-R44	1	E.B. BULL STD RH FD	1	275	275	467	545	40	MT2	5	1"	39,0	
			70691744			E.B. BULL STD RH	1							6	1"		
			70691743			E.B. BULL STD LH	1							6	1"		
20GD 301 Up			70619404	003-Q00-85	1	C.E. BULL STD CTR GD	1	254		1040		35	MT2	7	1"	69,3	
			70619720	003-Q00-73	1	C.E. BULL STD AMBI GD	2	254		1232		35	MT2	8	1"	82,1	
			70691722	003-657-L44	1	E.B. BULL STD LH FD	1	275	275	467	545	40	MT2	5	1"	39,0	
			70691721	003-657-R44	1	E.B. BULL STD RH FD	1	275	275	467	545	40	MT2	5	1"	39,0	
			70691744			E.B. BULL STD RH	1							6	1"		
			70691743			E.B. BULL STD LH	1							6	1"		
20GD			70609281	003-Q00-03	1	C.E. BULL STD CTR FD	1	203		3486		25	MT2	23	7/8"	132,7	
			70690676	003-633-R43	1	E.B. BULL STD RH FD	1	210	210	483	540	32	MT2	5	7/8"	26,0	
			70690675	003-633-L43	1	E.B. BULL STD LH FD	1	210	210	483	540	32	MT2	5	7/8"	26,0	
HD20		20G	70607398	003-Q00-05	1	C.E. BULL STD CTR FD	1	203		3200		19	MT2	21	7/8"	92,6	
			70690676	003-633-R43	1	E.B. BULL STD RH FD	1	210	210	483	540	32	MT2	5	7/8"	26,0	
			70690675	003-633-L43	1	E.B. BULL STD LH FD	1	210	210	483	540	32	MT2	5	7/8"	26,0	
		20B- 20BC to 301		70670089	003-Q00-21	1	C.E. BULL STD CTR	1	203		2457		19	MT2	16	7/8"	71,1
				70691674			E.B. BULL STD AMBI	2							6	7/8"	
							E.B. BULL STD										
		20B- 20BC to 301 Up		70607849	003-Q00-13	1	C.E. BULL STD CTR	1	203		2762		19	MT2	18	7/8"	79,9
			70691674			E.B. BULL STD AMBI	2							6	7/8"		
						E.B. BULL STD											

Our parts are not original but they are interchangeable with them. The O.E.M. Part Numbers are give for reference purposes only.

# FIAT-ALLIS-DOZERS&SCRAPERS

Cutting Edges and End Bits



**T O U G H  
COMPONENTS**

Tractor Type	Blade Model	O.E.M. Part Nr.	MTM Number	Ref.	Description	No Pcs	Millimeters					QI ty.	Nr. H.	Bolt Ø	W. Kg.	
							W1	W2	L1	L2	T					
FD20	Semi "U" AD20	8287749	003-Q00-39	1	C.E. BULL STD CTR FD	1	254		1672		25	MT2	11	1"	79,6	
		79030642	003-Q00-92	1	C.E. BULL STD AMBI FD	2	254		910		25	MT2	6	1"	43,3	
		8294446	003-968-R56	4	E.B. BULL STD RH HC	1	258	300	400	475	29	MT2	7	1"	28,5	
		8294447	003-968-L56	4	E.B. BULL STD LH HC	1	258	300	400	475	29	MT2	7	1"	28,5	
	Straight BD20	79030643	003-Q01-02	1	C.E. BULL STD CTR FD	1	254		816		25	MT2	5	1"	38,9	
		79030644	003-Q00-86	1	C.E. BULL STD AMBI FD	2	254		1005		25	MT2	7	1"	47,9	
		76004178	003-930-R55	4	E.B. BULL STD RH HC	4	258	300	430	535	29	MT2	7	1"	29,0	
		76004179	003-930-L55	4	E.B. BULL STD LH HC	4	258	300	430	535	29	MT2	7	1"	29,0	
BD20	Up to 8284678	8285415	003-Q00-15	1	C.E. BULL STD CTR FD	1	254		2720		25	MT2	18	3/4"	129,5	
		8280977			E.B. BULL STD RH	1						MT2	7	3/4"		
		8280978			E.B. BULL STD LH	1						MT2	7	3/4"		
	From 8284679	8287744	003-Q00-92	1	C.E. BULL STD AMBI FD	3	254		910		25	MT2	6	1"	43,3	
		8287740	003-941-R52	4	E.B. BULL STD RH HC	1	226	270	460	527	32	MT2	7	7/8"	29,5	
		8287741	003-941-L52	4	E.B. BULL STD LH HC	1	226	270	460	527	32	MT2	7	7/8"	29,5	
AD20	Up to 2882093	8285414	003-Q00-02	1	C.E. BULL STD CTR FD	1	254		3505		25	MT2	23	3/4"	166,9	
		8282113	003-925-R60	4	E.B. BULL STD RH HC	1	223	270	362	430	32	MT2	7	3/4"	25,5	
		8282114	003-925-L60	4	E.B. BULL STD LH HC	1	223	270	362	430	32	MT2	7	3/4"	25,5	
	From 2882094	8287749	003-Q00-39	1	C.E. BULL STD CTR FD	1	254		1672		25	MT2	11	1"	79,6	
		8287744	003-Q00-92	1	C.E. BULL STD AMBI FD	2	254		910		25	MT2	6	1"	43,3	
		8292090	003-925-L45	4	E.B. BULL STD LH HC	1	223	270	362	430	32	MT2	7	1"	25,5	
		8292091	003-925-R45	4	E.B. BULL STD RH HC	1	223	270	362	430	32	MT2	7	1"	25,5	
HD19	19GC	70607398	003-Q00-05	1	C.E. BULL STD CTR FD	1	203		3200		19	MT2	21	7/8"	92,6	
	19G	70690676	003-633-R43	1	E.B. BULL STD RH FD	1	210	210	483	540	32	MT2	5	7/8"	26,0	
		70690675	003-633-L43	1	E.B. BULL STD LH FD	1	210	210	483	540	32	MT2	5	7/8"	26,0	
	19BC	70670089	003-Q00-21	1	C.E. BULL STD CTR FD	1	203		2457		19	MT2	16	7/8"	71,1	
	19B	70691674			E.B. BULL STD AMBI	2							6	7/8"		
HD16B HD16 16B	Full "U" 16HU 9510301 U	70673565	003-Q00-41	1	C.E. BULL STD CTR FD	1	203		1670		19	MT2	11	7/8"	48,3	
		70673566	003-Q01-19	1	C.E. BULL STD AMBI FD	2	203		578		19	MT2	4	7/8"	16,7	
		70690676	003-633-R43	1	E.B. BULL STD RH FD	1	210	210	483	540	32	MT2	5	7/8"	26,0	
		70690675	003-633-L43	1	E.B. BULL STD LH FD	1	210	210	483	540	32	MT2	5	7/8"	26,0	
		70691058			E.B. BULL STD RH	1								6	7/8"	
		70691057			E.B. BULL STD LH	1								6	7/8"	
HD16	16GE	70614490	003-Q00-09	1	C.E. BULL STD CTR	1	203		2968		19	MT2	20	3/4"	85,9	
		70614492			E.B. BULL STD RH	1							5	1"		
		70614491			E.B. BULL STD LH	1							5	1"		
HD16B 16-B	16CSU 16HSU Semi "U" 19510301 U	70672194	003-Q00-60	1	C.E. BULL STD CTR FD	2	254		1387		25	MT2	9	1"	66,1	
		73113299	003-Q00-59	1	C.E. BULL STD CTR GD	2	254		1387		35	MT2	9	1"	92,5	
		73113303	003-Q00-58	1	C.E. BULL STD CTR HD	2	254		1387		40	MT2	9	1"	105,7	
		70661214			E.B. BULL STD RH	1							7	1"		
		70661213			E.B. BULL STD LH	1							7	1"		
		70673082	003-946-R59	4	E.B. BULL STD RH HC	1	265	320	437	534	35	MT2	7	1"	36,5	
		70673081	003-946-L59	4	E.B. BULL STD LH HC	1	265	320	437	534	35	MT2	7	1"	36,5	
		73113366			E.B. BULL STD RH	1							7	1"		
		73113365			E.B. BULL STD LH	1							7	1"		
HD16	16CSU 16HSU Semi "U"	70666909	003-Q00-20	1	C.E. BULL STD CTR FD	1	254		2629		19	MT2	17	1"	95,2	
		70661214			E.B. BULL STD RH	1							7	1"		
		70661213			E.B. BULL STD LH	1							7	1"		
		70673082	003-946-R59	4	E.B. BULL STD RH HC	1	265	320	437	534	35	MT2	7	1"	36,5	
		70673081	003-946-L59	4	E.B. BULL STD LH HC	1	265	320	437	534	35	MT2	7	1"	36,5	

# FIAT-ALLIS-DOZERS&SCRAPERS

Cutting Edges and End Bits



**T O U G H  
COMPONENTS**

Tractor Type	Blade Model	O.E.M. Part Nr.	MTM Number	Ref.	Description	No Pcs	Millimeters					QI ty.	Nr. H.	Bolt Ø	W. Kg.	
							W1	W2	L1	L2	T					
HD16B 16 B	16HA	70668615	003-Q00-47	1	C.E. BULL STD CTR FD	2	203		1560		19	MT2	10	7/8"	45,1	
	16CA	73113297	003-Q00-46	1	C.E. BULL STD CTR GD	2	200		1560		30	MT2	10	7/8"	70,2	
	Angle	73113298	003-Q00-45	1	C.E. BULL STD CTR HD	2	254		1560		35	MT2	10	7/8"	104,0	
	19510301 Up		70690676	003-633-R43	1	E.B. BULL STD RH FD	1	210	210	483	540	32	MT2	5	7/8"	26,0
			70690675	003-633-L43	1	E.B. BULL STD LH FD	1	210	210	483	540	32	MT2	5	7/8"	26,0
			70691058			E.B. BULL STD RH	1							6	7/8"	
			70691057			E.B. BULL STD LH	1							6	7/8"	
			73113302			E.B. BULL STD RH	1							6	7/8"	
			73113301			E.B. BULL STD LH	1							6	7/8"	
HD16	16GDC	70666908	003-Q00-10	1	C.E. BULL STD CTR FD	1	203		2924		19	MT2	19	7/8"	84,6	
	16GD	70617282	003-Q00-81	1	C.E. BULL STD CTR GD	1	200		1048		30	MT2	7	7/8"	47,2	
	16HA	70617297	003-Q00-87	1	C.E. BULL STD AMBI GD	2	200		935		30	MT2	6	7/8"	42,1	
	16CA		70690676	003-633-R43	1	E.B. BULL STD RH FD	1	210	210	483	540	32	MT2	5	7/8"	26,0
			70690675	003-633-L43	1	E.B. BULL STD LH FD	1	210	210	483	540	32	MT2	5	7/8"	26,0
			70691058			E.B. BULL STD RH	1							6	7/8"	
			70691057			E.B. BULL STD LH	1							6	7/8"	
			70635562			E.B. BULL STD RH	1							6	7/8"	
			70635561			E.B. BULL STD LH	1							6	7/8"	
HD16B 16 B	16HS Straight	70673000	003-Q00-67	1	C.E. BULL STD CTR FD	2	203		1301		19	MT2	9	7/8"	37,6	
		73113293	003-Q00-66	1	C.E. BULL STD CTR GD	2	200		1301		30	MT2	9	7/8"	58,5	
		73113294	003-Q00-65	1	C.E. BULL STD CTR HD	2	254		1301		35	MT2	9	7/8"	86,7	
		73691674			E.B. BULL STD AMBI	2							6	7/8"		
		70691686			E.B. BULL STD RH	1							6	7/8"		
		70691685			E.B. BULL STD LH	1							6	7/8"		
		73113296			E.B. BULL STD RH	1							6	7/8"		
		73113295			E.B. BULL STD LH	1							6	7/8"		
HD16	16HS	70646183	003-Q00-26	1	C.E. BULL STD CTR FD	1	203		2127		19	MT2	14	7/8"	61,5	
	16CS	70670089	003-Q00-21	1	C.E. BULL STD CTR FD	1	203		2457		19	MT2	16	7/8"	71,1	
	16BDC	70617303	003-Q00-99	1	C.E. BULL STD CTR GD	1	200		889		30	MT2	6	7/8"	40,0	
	16BD		70617305	003-Q01-05	1	C.E. BULL STD AMBI GD	2	200		781		30	MT2	5	7/8"	35,1
			70691674			E.B. BULL STD AMBI	2						6	7/8"		
			70691686			E.B. BULL STD RH	1						6	7/8"		
			70691685			E.B. BULL STD LH	1						6	7/8"		
HD15	15X	70612055	003-Q00-51	1	C.E. BULL STD CTR FD	1	203		1517		19	MT2	10	7/8"	43,9	
		70691674			E.B. BULL STD AMBI	2						6	7/8"			
	15GDC	70666908	003-Q00-10	1	C.E. BULL STD CTR FD	1	203		2924		19	MT2	19	7/8"	84,6	
		70690676	003-633-R43	1	E.B. BULL STD RH FD	1	210	210	483	540	32	MT2	5	7/8"	26,0	
	15GD	70690675	003-633-L43	1	E.B. BULL STD LH FD	1	210	210	483	540	32	MT2	5	7/8"	26,0	
	15GC	70607742	003-Q00-16	1	C.E. BULL STD CTR FD	1	203		2616		19	MT2	17	7/8"	75,7	
		70690676	003-633-R43	1	E.B. BULL STD RH FD	1	210	210	483	540	32	MT2	5	7/8"	26,0	
	15G	70690675	003-633-L43	1	E.B. BULL STD LH FD	1	210	210	483	540	32	MT2	5	7/8"	26,0	
	15BDC	70670089	003-Q00-21	1	C.E. BULL STD CTR FD	1	203		2457		19	MT2	16	7/8"	71,1	
		70691674			E.B. BULL STD AMBI	2							6	7/8"		
	15BC	70607664	003-Q01-97		C.E. BULL STD CTR FD	1	203		2159		19	MT2	14	7/8"	62,5	
		70691674			E.B. BULL STD AMBI	2							6	7/8"		
	14C	Straight	73117701	003-Q00-95	1	C.E. BULL STD CTR	1	203		908		19	MT2	6	3/4"	26,3
73117719			003-Q01-41	1	C.E. BULL STD AMBI	2	203		1063		19	MT2	7	3/4"	30,7	
73117714			003-969-R53	4	E.B. BULL STD RH HC	1	208	245	365	420	25	MT2	6	3/4"	18,0	
73117713			003-969-L53	4	E.B. BULL STD LH HC	1	208	245	365	420	25	MT2	6	3/4"	18,0	
Semi "U"		73117701	003-Q00-95	1	C.E. BULL STD CTR	1	203		908		19	MT2	6	3/4"	26,3	
		73117698	003-Q01-06	1	C.E. BULL STD AMBI	2	203		758		19	MT2	5	3/4"	21,9	

Our parts are not original but they are interchangeable with them. The O.E.M. Part Numbers are give for reference purposes only.



# FIAT-ALLIS-DOZERS&SCRAPERS

## Cutting Edges and End Bits



**T O U G H  
COMPONENTS**

Tractor Type	Blade Model	O.E.M. Part Nr.	MTM Number	Ref.	Description	No Pcs	Millimeters					QI ty.	Nr. H.	Bolt Ø	W. Kg.
							W1	W2	L1	L2	T				
14C	Semi "U"	73117700	003-916-R50	4	E.B. BULL STD RH HC	1	195	245	400	483	25	MT2	6	3/4"	19,0
		73117699	003-916-L59	4	E.B. BULL STD LH HC	1	195	245	400	483	25	MT2	6	3/4"	19,0
FD14	Angle	8294271	003-Q00-91	1	C.E. BULL STD CTR FD	1	203		912		19	MT2	6	3/4"	26,4
		8294668	003-Q01-06	1	C.E. BULL STD AMBI FD	2	203		758		19	MT2	5	3/4"	21,9
		8296486	003-916-R50	4	E.B. BULL STD RH HC	1	195	245	400	483	25	MT2	6	3/4"	19,0
		8296487	003-916-L50	4	E.B. BULL STD LH HC	1	195	245	400	483	25	MT2	6	3/4"	19,0
FD14 LGP		8294271	003-Q00-91	1	C.E. BULL STD CTR FD	1	203		912		19	MT2	6	3/4"	26,4
		8294668	003-Q01-06	1	C.E. BULL STD AMBI FD	2	203		758		19	MT2	5	3/4"	21,9
		8297646	003-921-M53	4	E.B. BULL STD RH HC	1	205	250	333	360	25	MT2	6	3/4"	16,0
		8297645	003-921-N53	4	E.B. BULL STD LH HC	1	205	250	333	360	25	MT2	6	3/4"	16,0
FD14E	Straight	8294271	003-Q00-91	1	C.E. BULL STD CTR FD	1	203		912		19	MT2	6	3/4"	26,4
		8294269	003-Q00-80	1	C.E. BULL STD AMBI FD	2	203		1063		19	MT2	7	3/4"	30,7
		8294273	003-969-R53	4	E.B. BULL STD RH HC	1	208	245	365	420	25	MT2	6	3/4"	18,0
		8294274	003-969-L53	4	E.B. BULL STD LH HC	1	208	245	365	420	25	MT2	6	3/4"	18,0
BD14	14C	8294271	003-Q00-91	1	C.E. BULL STD CTR FD	1	203		912		19	MT2	6	3/4"	26,4
		8294668	003-Q01-06	1	C.E. BULL STD AMBI FD	2	203		758		19	MT2	5	3/4"	21,9
		8296486	003-916-R50	4	E.B. BULL STD RH HC	1	195	245	400	483	25	MT2	6	3/4"	19,0
		8296487	003-916-L50	4	E.B. BULL STD LH HC	1	195	245	400	483	25	MT2	6	3/4"	19,0
		8281269	003-Q01-45	1	C.E. BULL STD CTR FD	1	203		2660		19	MT2	19	3/4"	76,9
		8280975	003-920-R49	4	E.B. BULL STD RH HC	1	210	250	415	475	25	MT2	7	3/4"	19,5
8280976	003-920-L49	4	E.B. BULL STD LH HC	1	210	250	415	475	25	MT2	7	3/4"	19,5		
BD14	14B	8285417	003-Q00-22	1	C.E. BULL STD CTR	1	203		2410		19	MT2	17	3/4"	69,7
BD12	12B	8292143	003-920-R49	4	E.B. BULL STD RH HC	1	210	250	415	475	25	MT2	7	3/4"	19,5
		8292144	003-920-L49	4	E.B. BULL STD LH HC	1	210	250	415	475	25	MT2	7	3/4"	19,5
AD14	14C	8294271	003-Q00-91	1	C.E. BULL STD CTR	1	203		912		19	MT2	6	3/4"	26,4
		8294264			C.E. BULL STD AMBI	2									
		8294273	003-969-R53	4	E.B. BULL STD RH HC	1	208	245	365	420	25	MT2	6	3/4"	18,0
		8294274	003-969-L53	4	E.B. BULL STD LH HC	1	208	245	365	420	25	MT2	6	3/4"	18,0
AD14	14B	8285416	003-Q00-06	1	C.E. BULL STD CTR	1	203		3072		19	MT2	21	3/4"	88,9
AD12	14C	8292092	003-613-R41	1	E.B. BULL STD RH FD	1	203	203	325	390	25	MT2	5	3/4"	30,8
		8292093	003-613-L41	1	E.B. BULL STD LH FD	1	203	203	325	390	25	MT2	5	3/4"	30,8
HD14 HD14C	351	70606955	003-Q01-96		C.E. BULL STD CTR	1	152		3019		19	MT2	15	3/4"	65,4
		70606953			E.B. BULL STD RH	1							5	3/4"	
		70606954			E.B. BULL STD LH	1							5	3/4"	
	419	70606872	003-Q01-94		C.E. BULL STD CTR	1	152		3112		16	MT2	16	5/8"	58,6
11B	Straight	70695517	003-Q01-10	1	C.E. BULL STD CTR	3	203		755		19	MT2	5	3/4"	21,8
		70691684	003-632-X67	1	E.B. BULL STD AMBI FD	2	210	210	457	457	32	MT2	6	3/4"	24,0
	Pushbeam	70606741			E.B. BULL STD AMBI	2							6	3/4"	
		70694316			E.B. BULL STD RH	1							6	3/4"	
		70694316			E.B. BULL STD LH	1							6	3/4"	
		70617310			E.B. BULL STD RH	1							6	3/4"	
		70617309			E.B. BULL STD LH	1							6	3/4"	
HD11B	11HA	70606548	003-Q00-14	1	C.E. BULL STD CTR	1	203		2749		19	MT2	18	3/4"	79,5
HD11	11GD	70694290			E.B. BULL STD RH	1						6	3/4"		
11B	11CA	70694289			E.B. BULL STD LH	1						6	3/4"		
		70607720			E.B. BULL STD LH	1						6	3/4"		
		70607719			E.B. BULL STD RH	1						6	3/4"		
		70694316			E.B. BULL STD RH	1						6	3/4"		
70694315			E.B. BULL STD LH	1						6	3/4"				
HD11B	11BD	70686595	003-Q00-24	1	C.E. BULL STD CTR	1	203		2286		19	MT2	15	3/4"	66,1
11B	cont.	70695517	003-Q01-10	1	C.E. BULL STD CTR	3	203		755		19	MT2	5	3/4"	21,8

Our parts are not original but they are interchangeable with them. The O.E.M. Part Numbers are give for reference purposes only.

# FIAT-ALLIS-DOZERS&SCRAPERS

Cutting Edges and End Bits



**T O U G H  
C O M P O N E N T S**

Tractor Type	Blade Model	O.E.M. Part Nr.	MTM Number	Ref.	Description	No Pcs	Millimeters					Ql ty.	Nr. H.	Bolt Ø	W. Kg.	
							W1	W2	L1	L2	T					
HD11B 11B	11BD	70694290			E.B. BULL STD RH	1						6	3/4"			
		70694289			E.B. BULL STD LH	1						6	3/4"			
		70607720			E.B. BULL STD LH	1						6	3/4"			
		70607719			E.B. BULL STD RH	1						6	3/4"			
		70686568			E.B. BULL STD RH	1						6	3/4"			
		70686567			E.B. BULL STD LH	1						6	3/4"			
HD11B HD11 11B	11HS	70606229	003-Q00-27	1	C.E. BULL STD CTR	1	203		2076		19	MT2	14	3/4"	60,1	
	11BD	70691684			E.B. BULL STD AMBI	2							6	3/4"		
	11CS	70606741			E.B. BULL STD AMBI	2							6	3/4"		
			70694316			E.B. BULL STD RH	1							6	3/4"	
			70694315			E.B. BULL STD LH	1							6	3/4"	
10C BD10	Angle 10C	8295487	003-Q01-00	1	C.E. BULL STD CTR FD	1	203		842		19	MT2	5	3/4"	24,4	
		8295488	003-Q01-16	1	C.E. BULL STD AMBI FD	2	203		674		19	MT2	5	3/4"	19,5	
		8295492	003-924-R54	4	E.B. BULL STD RH HC	1	210	250	360	420	25	MT2	6	3/4"	17,0	
		8295478	003-924-L54	4	E.B. BULL STD LH HC	1	210	250	360	420	25	MT2	6	3/4"	17,0	
10C AC10	Straight 10C	8294271	003-Q00-91	1	C.E. BULL STD CTR FD	3	203		912		19	MT2	6	3/4"	26,4	
		8294273	003-969-R53	4	E.B. BULL STD RH HC	1	208	245	365	420	25	MT2	6	3/4"	18,0	
		8294274	003-969-L53	4	E.B. BULL STD LH HC	1	208	245	365	420	25	MT2	6	3/4"	18,0	
10C	Semi "U"	73117717	003-Q01-95		C.E. BULL STD CTR FD	1	203		835		19	MT2	5	3/4"	24,2	
		73117718	003-Q01-16	1	C.E. BULL STD AMBI FD	2	203		674		19	MT2	5	3/4"	19,5	
	Angle	73117701	003-Q00-95	1	C.E. BULL STD CTR FD	2	203		908		19	MT2	6	3/4"	26,3	
		73117714	003-969-L53	4	E.B. BULL STD LH HC	1	208	245	365	420	25	MT2	6	3/4"	18,0	
		73117713	003-969-R53	4	E.B. BULL STD RH HC	1	208	245	365	420	25	MT2	6	3/4"	18,0	
	LGP Straight	79026239	003-Q00-54	1	C.E. BULL STD CTR FD	2	203		1402		19	MT2	9	3/4"	40,6	
		8297646	003-921-M53	4	E.B. BULL STD RH HC	1	205	250	333	360	25	MT2	6	3/4"	16,0	
	Straight	8297645	003-921-N53	4	E.B. BULL STD LH HC	1	205	250	333	360	25	MT2	6	3/4"	16,0	
		8298624	003-Q00-79	1	C.E. BULL STD CTR FD	2	203		1082		19	MT2	7	3/4"	31,3	
		8297646	003-921-M53	4	E.B. BULL STD RH HC	1	205	250	333	360	25	MT2	6	3/4"	16,0	
	8297645	003-921-N53	4	E.B. BULL STD LH HC	1	205	250	333	360	25	MT2	6	3/4"	16,0		
	10B	Semi "U"	8285413	003-Q00-25	1	C.E. BULL STD CTR FD	1	203		2200		19	MT2	15	3/4"	63,6
			73117712	003-924-R48	4	E.B. BULL STD RH HC	1	210	250	360	420	25	MT2	7	3/4"	17,0
73117711			003-924-L48	4	E.B. BULL STD LH HC	1	210	250	360	420	25	MT2	7	3/4"	17,0	
Angle		73117169	003-Q00-12	1	C.E. BULL STD CTR FD	1	203		2780		19	MT2	18	3/4"	80,4	
		8292092	003-613-R41	1	E.B. BULL STD RH FD	1	203	203	325	390	25	MT2	5	3/4"	30,8	
		8292093	003-613-L41	1	E.B. BULL STD LH FD	1	203	203	325	390	25	MT2	5	3/4"	30,8	
		73117710	003-917-R41	4	E.B. BULL STD RH HC	1	208	250	335	402	25	MT2	7	3/4"	17,0	
73117709	003-917-L41	4	E.B. BULL STD LH HC	1	208	250	335	402	25	MT2	7	3/4"	17,0			
BD10	10B	8285413	003-Q00-25	1	C.E. BULL STD CTR FD	1	203		2200		19	MT2	15	3/4"	63,6	
		8292100	003-924-R48	4	E.B. BULL STD RH HC	1	210	250	360	420	25	MT2	7	3/4"	17,0	
		8292101	003-924-L48	4	E.B. BULL STD LH HC	1	210	250	360	420	25	MT2	7	3/4"	17,0	
AD10	10B	8285418	003-Q00-12	1	C.E. BULL STD CTR FD	1	203		2780		19	MT2	18	3/4"	80,4	
		8292092	003-613-R41	1	E.B. BULL STD RH FD	1	203	203	325	390	25	MT2	5	3/4"	30,8	
		8292093	003-613-L41	1	E.B. BULL STD LH FD	1	203	203	325	390	25	MT2	5	3/4"	30,8	
HD10	437A	70606872	003-Q01-94		C.E. BULL STD CTR FD	1	152		3112		16	MT2	16	5/8"	56,8	
		70606879	003-Q01-93		C.E. BULL STD CTR FD	1	152		2913		16	MT2	14	5/8"	53,1	
	338A	70606979	003-Q01-92		C.E. BULL STD CTR FD	1	152		2997		16	MT2	15	5/8"	54,7	
		70606987			E.B. BULL STD RH	1							4	5/8"		
		70606988			E.B. BULL STD LH	1							4	5/8"		
cont.	338	70606986	003-Q01-91		C.E. BULL STD CTR FD	1	152		2660		16	MT2	13	5/8"	48,5	

Our parts are not original but they are interchangeable with them. The O.E.M. Part Numbers are give for reference purposes only.

# FIAT-ALLIS-DOZERS&SCRAPERS

Cutting Edges and End Bits



**T O U G H  
COMPONENTS**

Tractor Type	Blade Model	O.E.M. Part Nr.	MTM Number	Ref.	Description	No Pcs	Millimeters					QI ty.	Nr. H.	Bolt Ø	W. Kg.	
							W1	W2	L1	L2	T					
HD10	338	70606987			E.B. BULL STD RH	1						4	5/8"			
		70606988			E.B. BULL STD LH	1						4	5/8"			
	511A	70607302	003-Q01-91			C.E. BULL STD CTR FD	1	203		1975		19	MT2	13	3/4"	57,1
		70606742				E.B. BULL STD AMBI	2						6	7/8"		
	511	70607353				C.E. BULL STD CTR FD	1									
		70606742				E.B. BULL STD AMBI	2						6	7/8"		
HD9	9X	70607826	003-Q01-88		C.E. BULL STD CTR FD	1	203		1518		19	MT2	10	3/4"	43,9	
		70606228	003-632-X67	1	E.B. BULL STD AMBI FD	2	210	210	457	457	32	MT2	6	3/4"	24,0	
		70606741				E.B. BULL STD AMBI	2						6	3/4"		
	9G	70607718	003-Q01-87			C.E. BULL STD CTR FD	1	203		2438		19	MT2	16	3/4"	70,5
		70694290				E.B. BULL STD RH	1						6	3/4"		
		70694289				E.B. BULL STD LH	1						6	3/4"		
		70607719				E.B. BULL STD RH	1						6	3/4"		
		70607720				E.B. BULL STD LH	1						6	3/4"		
	9B	70607673	003-Q01-86			C.E. BULL STD CTR FD	1	203		1981		19	MT2	13	3/4"	57,3
		70691684	003-632-X67	1		E.B. BULL STD AMBI FD	2	210	210	457	457	32	MT2	6	3/4"	24,0
		70606741				E.B. BULL STD AMBI	2						6	3/4"		
	FD9	Angle	76005429	003-Q01-07	1	C.E. BULL STD CTR FD	1	203		756		19	MT2	5	3/4"	21,9
8294271			003-Q00-91	1	C.E. BULL STD AMBI FD	2	203		912		19	MT2	6	3/4"	26,4	
8294273			003-969-R53	4	E.B. BULL STD RH HC	1	208	245	365	420	25	MT2	6	3/4"	18,0	
8294273			003-969-R53	4	E.B. BULL STD RH HC	1	208	245	365	420	25	MT2	6	3/4"	18,0	
Semi "U"		76005845	003-Q00-83	1		C.E. BULL STD CTR FD	2	203		1042		19	MT2	7	3/4"	30,1
		76005120	003-942-R54	4		E.B. BULL STD RH HC	1	201	250	350	470	25	MT2	6	3/4"	18,0
		76005121	003-942-L54	4		E.B. BULL STD LH HC	1	201	250	350	470	25	MT2	6	3/4"	18,0
Straight		76005189	003-Q00-33	1		C.E. BULL STD CTR FD	1	203		1802		19	MT2	12	3/4"	52,1
		8294273	003-969-R53	4		E.B. BULL STD RH HC	1	208	245	365	420	25	MT2	6	3/4"	18,0
		8294274	003-969-L53	4		E.B. BULL STD LH HC	1	208	245	365	420	25	MT2	6	3/4"	18,0
BD9	9D	8285942	003-Q00-19	1	C.E. BULL STD CTR FD	1	152		2504		16	MT2	17	5/8"	45,7	
		8291186	003-601-R47	1	E.B. BULL STD RH FD	1	152	152	215	236	16	MT2	5	5/8"	4,5	
		8291187	003-601-L47	1	E.B. BULL STD LH FD	1	152	152	215	236	16	MT2	5	5/8"	4,5	
AD9 AD7	9B	8283256	003-Q00-17	1	C.E. BULL STD CTR FD	1	152		2613		16	MT2	19	5/8"	47,7	
	7C	8292098	003-919-R40	4	E.B. BULL STD RH HC	1	172	195	282	340	20	MT2	5	5/8"	9,0	
	7B	8292099	003-919-L40	4	E.B. BULL STD LH HC	1	172	195	282	340	20	MT2	5	5/8"	9,0	
BD8 BD7	8B	8283232	003-Q00-32	1	C.E. BULL STD CTR FD	1	152		1905		16	MT2	13	5/8"	34,7	
	7C	8292102	003-911-R46	4	E.B. BULL STD RH HC	1	165	195	343	405	20	MT2	7	5/8"	11,0	
	7B	8292103	003-911-L46	4	E.B. BULL STD LH HC	1	165	195	343	405	20	MT2	7	5/8"	11,0	
AD8	8B	8285291	003-Q00-18	1	C.E. BULL STD CTR FD	1	152		2570		16	MT2	17	5/8"	46,9	
		8292098	003-919-R40	4	E.B. BULL STD RH HC	1	172	195	282	340	20	MT2	5	5/8"	9,0	
		8292099	003-919-L40	4	E.B. BULL STD LH HC	1	172	195	282	340	20	MT2	5	5/8"	9,0	
BD-7C 8		8283232	003-Q00-32	1	C.E. BULL STD CTR FD	1	152		1905		16	MT2	13	5/8"	34,7	
		8292102	003-911-R46	4	E.B. BULL STD RH HC	1	165	195	343	405	20	MT2	7	5/8"	11,0	
		8292103	003-911-L46	4	E.B. BULL STD LH HC	1	165	195	343	405	20	MT2	7	5/8"	11,0	
		8283234	003-911-R58	4	E.B. BULL STD RH HC	1	165	195	343	405	20	MT2	7	5/8"	10,5	
		8283233	003-911-L58	4	E.B. BULL STD LH HC	1	165	195	343	405	20	MT2	7	5/8"	10,5	
BD-7		8280320	003-Q01-85		C.E. BULL STD CTR FD	1	203		1910		16	MT2	14	5/8"	46,5	
		8280321			E.B. BULL STD RH	1						7	5/8"			
		8280322				E.B. BULL STD LH	1						7	5/8"		
		44057412	003-Q01-84			C.E. BULL STD CTR FD	1	203		2020		19	MT2	16	5/8"	58,4
		44057413				E.B. BULL STD RH	1						7	5/8"		
		44057414				E.B. BULL STD LH	1						7	5/8"		

# FIAT-ALLIS-DOZERS&SCRAPERS

Cutting Edges and End Bits



**T O U G H  
C O M P O N E N T S**

Tractor Type	Blade Model	O.E.M. Part Nr.	MTM Number	Ref.	Description	No Pcs	Millimeters					Qt ty.	Nr. H.	Bolt Ø	W. Kg.	
							W1	W2	L1	L2	T					
FD7	Angle	79033806			C.E. BULL STD CTR FD	2										
		8298497	003-Q01-17	1	C.E. BULL STD AMBI FD	2	152		607		16	MT2	4	3/4"	11,1	
		79025223			E.B. BULL STD AMBI	2							4	3/4"		
	Semi "U"	79033808				C.E. BULL STD CTR FD	2									
		8298398	003-Q01-22	1	C.E. BULL STD AMBI FD	2	152		534		16	MT2	4	3/4"	9,7	
		79025223			E.B. BULL STD AMBI	2							4	3/4"		
	Straight	79025222	003-Q01-15	1	C.E. BULL STD CTR	2	152		723		16	MT2	5	3/4"	13,2	
		79025223			E.B. BULL STD AMBI	2							4	3/4"		
		79033809	003-Q01-23	1	C.E. BULL STD CTR FD	1	152		528		16	MT2	3	3/4"	9,6	
		8298398	003-Q01-22	1	C.E. BULL STD AMBI FD	2	152		534		16	MT2	4	3/4"	9,7	
79030668				E.B. BULL STD AMBI	2							4	3/4"			
AD7 AD7C		8283256	003-Q00-17	1	C.E. BULL STD CTR FD	1	152		2613		16	MT2	19	5/8"	47,7	
		8274643	003-919-R40	4	E.B. BULL STD RH HC	1	172	195	282	340	20	MT2	5	5/8"	9,0	
		8274644	003-919-L40	4	E.B. BULL STD LH HC	1	172	195	282	340	20	MT2	5	5/8"	9,0	
		8292098	003-919-R40	4	E.B. BULL STD RH HC	1	172	195	282	340	20	MT2	5	5/8"	9,0	
		8292099	003-919-L40	4	E.B. BULL STD LH HC	1	172	195	282	340	20	MT2	5	5/8"	9,0	
HD-7W	325A	70607011	003-Q01-83		C.E. BULL STD CTR FD	1	152		2451		16	MT2	13	5/8"	44,7	
		70607004			E.B. BULL STD RH	1							4	5/8"		
		70607005			E.B. BULL STD LH	1							4	5/8"		
HD7	325	70607003	003-Q01-82		C.E. BULL STD CTR FD	1	152		2153		16	MT2	11	5/8"	39,3	
		70607004			E.B. BULL STD RH	1							4	5/8"		
		70607005			E.B. BULL STD LH	1							4	5/8"		
HD-7W	424A	70606888	003-Q01-81		C.E. BULL STD CTR FD	1	152		2562		16	MT2	17	5/8"	46,7	
HD7	424	70606959	003-Q01-80		C.E. BULL STD CTR FD	1	152		2286		16	MT2	15	5/8"	41,7	
AD6		8269270	003-Q00-23		C.E. BULL STD CTR FD	1	152		2316		16	MT2	16	5/8"	45,9	
		8269271			E.B. BULL STD RH FD	1										
		8269272			E.B. BULL STD LH FD	1										
HD6 HD6B HD6E EP	6GE	70612678	003-Q01-78		C.E. BULL STD CTR FD	1	152		2438		16	MT2	16	5/8"	44,5	
	6HA	70619722	003-Q01-79		C.E. BULL STD CTR GD	1	152		2438		19	MT2	16	5/8"	52,8	
		70612679			E.B. BULL STD LH	1							4	5/8"		
		70612680			E.B. BULL STD RH	1							4	5/8"		
HD6	6AGE	70614704	003-Q01-76		C.E. BULL STD CTR FD	1	152		2000		16	MT2	13	5/8"	36,5	
	6HA	70619721	003-Q01-77		C.E. BULL STD CTR GD	1	152		2000		19	MT2	13	5/8"	43,3	
		70612679			E.B. BULL STD LH	1							4	5/8"		
		70612680			E.B. BULL STD RH	1							4	5/8"		
HD6 HD6B HD6E EP	6BE	70619541	003-Q01-75		C.E. BULL STD CTR FD	1	152		1670		16	MT2	11	5/8"	30,5	
	6HS	70609562			E.B. BULL STD AMBI	2							4	5/8"		
HD6	6ABE	70619548	003-Q01-73		C.E. BULL STD CTR FD	1	152		1264		16	MT2	9	5/8"	23,1	
	6HS	70609562			E.B. BULL STD AMBI	2							4	5/8"		
FD5		79025222	003-Q01-15	1	C.E. BULL STD CTR FD	2	152		723		16	MT2	5	3/4"	13,2	
		8297719	003-606-R57	1	E.B. BULL STD RH FD	1	152	152	410	450	16	MT2	4	3/4"	8,0	
		8297720	003-606-L57	1	E.B. BULL STD LH FD	1	152	152	410	450	16	MT2	4	3/4"	8,0	
AD5		8270617	003-Q01-38	1	C.E. BULL STD CTR FD	1	165		2166		16	MT2	15	5/8"	42,9	
		8270619			E.B. BULL STD RH	1							4	5/8"		
		8270618			E.B. BULL STD LH	1							4	5/8"		
HD5	5AGF	70607891	003-Q01-72		C.E. BULL STD CTR FD	1	152		2165		16	MT2	15	5/8"	39,5	
		70606759			E.B. BULL STD RH	1							4	5/8"		
		70606760			E.B. BULL STD LH	1							4	5/8"		
cont.																

# FIAT-ALLIS-DOZERS&SCRAPERS

Cutting Edges and End Bits



**T O U G H  
C O M P O N E N T S**

Tractor Type	Blade Model	O.E.M. Part Nr.	MTM Number	Ref.	Description	No Pcs	Millimeters					QI ty.	Nr. H.	Bolt Ø	W. Kg.
							W1	W2	L1	L2	T				
HD5	5ABF	70607894	003-Q01-71		C.E. BULL STD CTR FD	1	152		1264		16	MT2	8	5/8"	23,1
		70609562			E.B. BULL STD AMBI	2							4	5/8"	
	5BGF	70607880	003-Q01-70		C.E. BULL STD CTR FD	1	152		2616		16	MT2	17	5/8"	47,7
		70606759			E.B. BULL STD RH	1							4	5/8"	
		70606760			E.B. BULL STD LH	1							4	5/8"	
	5BBF	70607544	003-Q01-69		C.E. BULL STD CTR FD	1	152		1676		16	MT2	11	5/8"	30,6
		70609562			E.B. BULL STD AMBI	2							4	5/8"	
	5BG 5BGE	70607153	003-Q01-68		C.E. BULL STD CTR FD	1	152		2515		16	MT2	15	5/8"	45,9
		70606759			E.B. BULL STD RH	1							4	5/8"	
		70606760			E.B. BULL STD LH	1							4	5/8"	
	5AG 5AGE	70607477	003-Q01-67		C.E. BULL STD CTR FD	1	152		2067		16	MT2	13	5/8"	37,7
		70606759			E.B. BULL STD RH	1							4	5/8"	
		70606760			E.B. BULL STD LH	1							4	5/8"	
	5BB 5BBE	70607362	003-Q01-66		C.E. BULL STD CTR FD	1	152		1676		16	MT2	11	5/8"	30,6
70607363				E.B. BULL STD AMBI	2							4	5/8"		
5AB 5ABE	70607478	003-Q01-65		C.E. BULL STD CTR FD	1	152		1264		16	MT2	9	5/8"	23,1	
	70607363			E.B. BULL STD AMBI	2							4	5/8"		
AD4		8268514	003-Q00-35	1	C.E. BULL STD CTR FD	1	152		1756		16	MT2	16	5/8"	32,0
		8269567			E.B. BULL STD RH	1							3		
		8269568			E.B. BULL STD LH	1							3		
		8269569			E.B. BULL STD RH	1							5		
		8269570			E.B. BULL STD LH	1							5		
HD4	4100	70410646	003-Q01-63		C.E. BULL STD CTR FD	1	152		1230		16	MT2	8	5/8"	22,4
		70410647	003-Q01-64		C.E. BULL STD CTR	1	152		1738		16	MT2	11	5/8"	31,7
		70410588			E.B. BULL STD RH	1						4	5/8"		
		70410589			E.B. BULL STD LH	1						4	5/8"		
	493	70410587	003-Q01-62		C.E. BULL STD CTR FD	1	152		1560		16	MT2	10	5/8"	28,5
		70410588			E.B. BULL STD RH	1						4	5/8"		
		70410589			E.B. BULL STD LH	1						4	5/8"		
HD3 HD4	1080	70407044	003-Q01-61		C.E. BULL STD CTR FD	1	152		1573		16	MT2	7	5/8"	28,7
	1081	70407045			E.B. BULL STD AMBI	2						2	5/8"		
	Angle Inside Pushbeam														
1090 Angle Outside Pushbeam	70407023	003-Q01-60		C.E. BULL STD CTR FD	1	152		1829		16	MT2	8	5/8"	33,4	
	70407045			E.B. BULL STD AMBI	2							2	5/8"		
	70409732			E.B. BULL STD AMBI	2							2	5/8"		
653	Inside Pushbeam	70410860	003-Q01-58		C.E. BULL STD CTR FD	1	152		1560		16	MT2	10	5/8"	28,5
		70612679			E.B. BULL STD LH	1						4	5/8"		
		70612680			E.B. BULL STD RH	1						4	5/8"		
652		70410861	003-Q01-57		C.E. BULL STD CTR FD	1	152		1738		16	MT2	11	5/8"	31,7
		70612679			E.B. BULL STD LH	1						4	5/8"		
		70612680			E.B. BULL STD RH	1						4	5/8"		
FA120	Angle	76005429	003-Q01-07	1	C.E. BULL STD CTR FD	1	203		756		19	MT2	5	3/4"	21,9
		8294271	003-Q00-91	1	C.E. BULL STD AMBI FD	2	203		912		19	MT2	6	3/4"	26,4
		8294273	003-969-R53	4	E.B. BULL STD RH HC	1	208	245	365	420	25	MT2	6	3/4"	18,0
		8294274	003-969-L53	4	E.B. BULL STD LH HC	1	208	245	365	420	25	MT2	6	3/4"	18,0
FA200	Angle	8294271	003-Q00-91	1	C.E. BULL STD CTR FD	1	203		912		19	MT2	6	3/4"	26,4
		8294269	003-Q00-80	1	C.E. BULL STD AMBI FD	2	203		1063		19	MT2	7	3/4"	30,7
cont.															

Our parts are not original but they are interchangeable with them. The O.E.M. Part Numbers are give for reference purposes only.

# FIAT-ALLIS-DOZERS&SCRAPERS

Cutting Edges and End Bits



**T O U G H  
C O M P O N E N T S**

Tractor Type	Blade Model	O.E.M. Part Nr.	MTM Number	Ref.	Description	No Pcs	Millimeters					Qt ty.	Nr. H.	Bolt Ø	W. Kg.
							W1	W2	L1	L2	T				
FA200	Angle	8294273	003-969-R53	4	E.B. BULL STD RH HC	1	208	245	365	420	25	MT2	6	3/4"	18,0
		8294274	003-969-L53	4	E.B. BULL STD LH HC	1	208	245	365	420	25	MT2	6	3/4"	18,0
S-560	2359-2366	70184532	003-S00-46		C.E. SCR STD CTR	1	460		1676		25	MT2	19	1"	144,6
	Except 2363&2365	70184533	003-S00-47		C.E. SCR STD AMBI	2	305		800		25	MT2	9	1"	45,8
		70184527			E.B. SCR STD AMBI	2									
	2357	70196707	003-S00-42		C.E. SCR STD CTR	2	460		756		35	MT2	5	1 1/4"	91,3
	2358	70196706	003-S00-43		C.E. SCR STD AMBI	2	355		756		35	MT2	5	1 1/4"	70,4
	2363	70187263			E.B. SCR STD RH	1									
	2365	70187264			E.B. SCR STD LH	1									
	2367-2692														
S-560	2692-Up	70195666	003-S00-44		C.E. SCR STD CTR	2	585		822		35	MT2	5	1 1/4"	126,2
S-562		70196657	003-S00-48		C.E. SCR STD AMBI	2	380		822		35	MT2	5	1 1/4"	82,0
562-C		70189990			E.B. SCR STD AMBI	2									
		70196658	003-S00-45		C.E. SCR STD CTR	2	585		822		35	MT2	5	1 1/4"	126,2
		70196657	003-S00-48		C.E. SCR STD AMBI	2	380		822		35	MT2	5	1 1/4"	82,0
		70189990			E.B. SCR STD AMBI	2									
460-B 460-C		70196655	003-S00-41		C.E. SCR STD CTR	2	508		756		35	MT2	10	1"	100,8
		70196656	003-S00-50		C.E. SCR STD AMBI	2	406		756		35	MT2	5	1"	80,6
		70198598	003-S00-02	2	C.E. SCR STD CTR	2	406		756		35	MT2	10	1"	80,6
		70198599	003-S00-49		C.E. SCR STD AMBI	2	406		756		35	MT2	5	1"	80,6
		70193296			E.B. SCR STD AMBI	2									
		70199579			E.B. SCR STD AMBI	2									
263-B	Elev. Scraper	70198487	003-S00-03	3	C.E. SCR STD CTR	4	355		756		25	MT2	18	3/4"	50,3
		70198496			C.E. SCR STD AMBI	2	152		1592		19	MT2	12	3/4"	34,5
		73107766			E.B. SCR STD AMBI	2									
		70198274			E.B. SCR STD AMBI	2									
260-E 261-B	Ser A Elev. Scraper	70198487	003-S00-03	3	C.E. SCR STD CTR	4	355		756		25	MT2	18	3/4"	50,3
		70198496			C.E. SCR STD AMBI	2	152		1592		19	MT2	12	3/4"	34,5
		70198274			E.B. SCR STD AMBI	2									
260-B 262-B		73105309	003-S00-04	2	C.E. SCR STD CTR	2	406		756		25	MT2	10	1"	56,7
		73105310	003-S00-51	1	C.E. SCR STD AMBI	2	330		756		25	MT2	5	1"	46,8
		70182706			E.B. SCR STD AMBI	2									
		73106180			E.B. SCR STD AMBI	2									
		73107766			E.B. SCR STD AMBI	2									
TS-260	4001-Up (New Style)	73103472	003-S00-36		C.E. SCR STD CTR	3	305		959		25	MT2	6	7/8"	54,8
		70182406	003-S00-37		C.E. SCR STD CTR		355		959		25	MT2	6	7/8"	63,8
		70686801	003-S00-52		C.E. SCR STD AMBI	2	305		991		25	MT2	6	7/8"	56,7
		70181739			E.B. SCR STD AMBI	2									
		70182706			E.B. SCR STD AMBI	2									
TS-200 TS-260	Up to 4001	70674644	003-S00-33		C.E. SCR STD CTR	1	355		2584		19	MT2	38	3/4"	130,7
		70175073	003-S00-21		C.E. SCR STD CTR	1	305		2584		19	MT2	38	3/4"	112,3
		70175068	003-S00-22		C.E. SCR STD CTR		305		1508		19	MT2	28	3/4"	65,5
		70175069	003-S00-53		C.E. SCR STD AMBI	2	254		537		19	MT2	5	3/4"	19,4
		70172757			E.B. SCR STD AMBI	2									
		70175885			E.B. SCR STD AMBI	2									
		73105172			E.B. SCR STD AMBI	2									
160-E 161		70675188	003-S00-29		C.E. SCR STD CTR FD	1	305		1672		25	MT2	11	3/4"	95,6
		70675187	003-S00-30		C.E. SCR STD AMBI FD	2	305		493		25	MT2	3	3/4"	28,2
		70687035	003-S00-01	2	C.E. SCR STD CTR GD	1	330		1672		25	MT2	22	3/4"	106,5
		70687036	003-S00-05	2	C.E. SCR STD AMBI GD	2	330		493		25	MT2	6	3/4"	30,5
	cont.		70198274		E.B. SCR STD AMBI	2									

Our parts are not original but they are interchangeable with them. The O.E.M. Part Numbers are give for reference purposes only.

# FIAT-ALLIS-DOZERS&SCRAPERS

Cutting Edges and End Bits



**T O U G H  
COMPONENTS**

Tractor Type	Blade Model	O.E.M. Part Nr.	MTM Number	Ref.	Description	No Pcs	Millimeters					Qt ty.	Nr. H.	Bolt Ø	W. Kg.
							W1	W2	L1	L2	T				
TS-160		70179888	003-S00-27		C.E. SCR STD CTR	3	254		806		25	MT2	5	7/8"	38,4
		70182405	003-S00-28		C.E. SCR STD CTR		305		806		25	MT2	5	7/8"	46,1
		70686951	003-S00-54		C.E. SCR STD AMBI	2	254		833		25	MT2	5	7/8"	39,7
		70181781			E.B. SCR STD AMBI	2									
		70182705			E.B. SCR STD AMBI	2									
TS-360	2001-Up	70182616	003-S00-26		C.E. SCR STD CTR FD	1	355		1519		25	MT2	10	1"	101,1
TS-460 (New Style)	3800	70182617	003-S00-62		C.E. SCR STD AMBI FD	2	305		756		25	MT2	5	1"	43,2
		70182665	003-S00-63		C.E. SCR STD AMBI GD	2	355		756		25	MT2	5	1"	50,3
		70181739			E.B. SCR STD AMBI	2									
		70182706			E.B. SCR STD AMBI	2									
C-114		70674648	003-S00-23		C.E. SCR STD CTR	1	355		2946		19	MT2	44	3/4"	149,0
C-314		70175083	003-S00-24		C.E. SCR STD CTR	1	305		2946		19	MT2	44	3/4"	128,0
C-315		70175070	003-S00-25		C.E. SCR STD CTR	1	305		1864		19	MT2	34	3/4"	81,0
S-300		70175069			C.E. SCR STD AMBI	2									
TS-300		70175072			E.B. SCR STD AMBI	2									
		73105179			E.B. SCR STD AMBI	2									
TS-360 (Old Style)															
C-108		70175073	003-S00-21		C.E. SCR STD CTR	1	305		2584		19	MT2	38	3/4"	112,3
		70175068	003-S00-22		C.E. SCR STD CTR		305		1508		19	MT2	28	3/4"	65,5
		70175069	003-S00-53		C.E. SCR STD AMBI	2	254		537		19	MT2	5	3/4"	19,4
		70674644	003-S00-44		C.E. SCR STD CTR		355		2584		19	MT2	38	3/4"	130,7
		70175072			E.B. SCR STD AMBI	2									
		73105179			E.B. SCR STD AMBI	2									
C-106		70175078	003-S00-18		C.E. SCR STD CTR		305		2356		19	MT2	22	3/4"	102,4
		70175077	003-S00-19		C.E. SCR STD CTR	1	254		2350		19	MT2	22	3/4"	85,1
		70175071	003-S00-20		C.E. SCR STD CTR		254		1270		19	MT2	12	3/4"	46,0
		70175075	003-S00-56		C.E. SCR STD AMBI	2	203		537		19	MT2	5	3/4"	15,5
		70175074			E.B. SCR STD AMBI	2									
C-86 C-104	37-Up	70136532	003-S00-15		C.E. SCR STD CTR FD	1	305		1518		25	MT2	15	3/4"	86,9
		70137709	003-S00-16		C.E. SCR STD CTR GD	1	355		1518		25	MT2	15	3/4"	101,0
		70136711	003-S00-14		C.E. SCR STD CTR	1	355		1518		25	MT2	15	3/4"	101,0
		70135884			C.E. SCR STD AMBI	2									
		70141522			E.B. SCR STD AMBI	2									
C-84 C-86 C-104	71-Up to 37	70136532	003-S00-15		C.E. SCR STD CTR	1	305		1518		25	MT2	15	3/4"	86,9
		70137709	003-S00-16		C.E. SCR STD CTR	1	355		1518		25	MT2	15	3/4"	101,0
		70136711	003-S00-14		C.E. SCR STD CTR	1	355		1518		25	MT2	15	3/4"	101,0
		70135884			C.E. SCR STD AMBI	2									
		70136531	003-S00-57		C.E. SCR STD AMBI	2	305		603		25	MT2	6	3/4"	34,5
		70134236			E.B. SCR STD AMBI	2									
C-84	To-71	70132161	003-S00-12		C.E. SCR STD CTR	3	305		890		25	MT2	9	3/4"	50,9
		70136721	003-S00-13		C.E. SCR STD CTR	3	355		1518		25	MT2	15	3/4"	101,0
		70136711	003-S00-14		C.E. SCR STD CTR	1	355		1518		25	MT2	15	3/4"	101,0
		70135884			C.E. SCR STD AMBI	2									
		70136720			E.B. SCR STD AMBI	2									
C-74		70136484	003-S00-10		C.E. SCR STD CTR	1	305		1213		25	MT2	12	3/4"	69,4
		70136676	003-S00-11		C.E. SCR STD CTR	1	355		1213		25	MT2	12	3/4"	80,7
		70136531	003-S00-57		C.E. SCR STD AMBI	2	305		603		25	MT2	6	3/4"	34,5
C-61		70132261	003-S00-09		C.E. SCR STD CTR	1	305		1165		25	MT2	8	3/4"	66,4
C-42		70176040	003-S00-08		C.E. SCR STD CTR	1	254		838		19	MT2	8	3/4"	30,3
C-44		70175075	003-S00-56		C.E. SCR STD AMBI	2	203		537		19	MT2	5	3/4"	15,5

Our parts are not original but they are interchangeable with them. The O.E.M. Part Numbers are give for reference purposes only.

# FIAT-ALLIS-DOZERS&SCRAPERS

Cutting Edges and End Bits



**T O U G H  
COMPONENTS**

Tractor Type	Blade Model	O.E.M. Part Nr.	MTM Number	Ref.	Description	No Pcs	Millimeters					Ql ty.	Nr. H.	Bolt Ø	W. Kg.
							W1	W2	L1	L2	T				
CW-10		70145361	003-S00-06		C.E. SCR STD CTR	1	230		2277		19	MT2	19	3/4"	74,6
		70180201	003-S00-07		C.E. SCR STD CTR		230		1518		19	MT2	11	3/4"	49,8
		70180202	003-S00-55		C.E. SCR STD AMBI	2	230		375		19	MT2	4	3/4"	12,3